

MADE IN U.S.A.

*Windham  
Weapony*

*Windham  
Weapony*

PS00195

CAL MULT  
MOD. WW-

# OPERATING & SAFETY MANUAL

**CAREFULLY READ THIS INSTRUCTION MANUAL PRIOR TO LOADING AND FIRING THIS FIREARM. FOLLOW ALL INSTRUCTIONS ON THE PROPER HANDLING AND SAFE USE OF THIS FIREARM!**

## **BEWARE OF DANGEROUS PROCEDURES!**

**WARNING!** IF THIS FIREARM IS CARELESSLY OR IMPROPERLY HANDLED, UNINTENTIONAL DISCHARGE COULD RESULT AND COULD CAUSE INJURY, DEATH, OR DAMAGE TO PROPERTY.

**WARNING!** THIS WEAPON COULD CHAMBER A ROUND IF IT IS DROPPED OR JARRED WITH A LOADED MAGAZINE IN PLACE AND WITH THE BOLT CARRIER ASSEMBLY LOCKED TO THE REAR.

**WARNING!** BE SURE CAM PIN IS INSTALLED IN THE BOLT GROUP. IF IT ISN'T, THE RIFLE CAN STILL FIRE AND WILL EXPLODE!

**WARNING!** IF THERE IS WATER IN THE BARREL, DO NOT FIRE THE RIFLE. IT COULD EXPLODE!

**CAUTION!** USE ONLY CLEAN, DRY, HIGH QUALITY COMMERCIALY MANUFACTURED AMMUNITION WHICH IS APPROPRIATE TO THE CALIBER OF YOUR FIREARM. WINDHAM WEAPONRY DOES NOT RECOMMEND THE USE OF REMANUFACTURED OR HAND LOADED AMMUNITION BECAUSE IT MAY DAMAGE YOUR RIFLE.

**CAUTION!** IF THE RIFLE STOPS FIRING (A MISFIRE) WITH A LIVE ROUND IN THE CHAMBER OF A HOT BARREL, REMOVE THE ROUND FAST! HOWEVER, IF YOU CANNOT REMOVE IT WITHIN 10 SECONDS, REMOVE MAGAZINE AND WAIT 15 MINUTES WITH THE RIFLE POINTING IN A SAFE DIRECTION SO YOU WON'T BE HURT BY A POSSIBLE ROUND "COOKING-OFF" (I.E. THE ROUND DETONATING FROM THE HEAT OF THE BARREL). ALWAYS KEEP YOUR FACE AWAY FROM THE EJECTION PORT WHILE CLEARING A HOT CHAMBER.

**CAUTION!** IF RIFLE'S BOLT FAILS TO UNLOCK, AND YOU TRY TO FREE IT BY TAPPING THE BUTTSTOCK ON THE GROUND WHILE PULLING ON THE CHARGING HANDLE, KEEP YOURSELF CLEAR OF THE MUZZLE! PLACE THE SAFETY SELECTOR LEVER ON SAFE.

**CAUTION!** IF YOU HEAR A NOTICEABLE DIFFERENCE IN SOUND OR RECOIL DURING FIRING, STOP FIRING! EITHER CONDITION COULD INDICATE AN INCOMPLETE POWDER BURN AND/OR A BULLET STUCK IN THE BORE.



**CAREFULLY READ THIS INSTRUCTION MANUAL PRIOR TO LOADING AND FIRING THIS FIREARM. FOLLOW ALL INSTRUCTIONS ON THE PROPER HANDLING AND SAFE USE OF THIS FIREARM!**



*This manual is based upon the U.S. Gov't. Issue Manual for M16 A2 Rifles, and includes maintenance procedures for all Windham Weaponry semi-automatic firearms with either Aluminum or Carbon Fiber Receivers.*

Windham Weaponry is steadfast in its goal to produce the finest AR15 type rifle and carbine possible, and we encourage our customers to follow further developments on our website.

[www.windhamweaponry.com](http://www.windhamweaponry.com)

The Windham Weaponry Team thanks you for your purchase of this fine rifle, and we hope you will enjoy it safely for many years. If you need parts, service or advice concerning your rifle, we are never more than a phone call away, and will be pleased to help you.

In the meantime, we encourage you to shoot safely, to enjoy the great outdoors, and to provide us feedback in our quest to produce the finest rifles in the world.

Thanks, from the  
**Windham Weaponry Team**

## **YOUR WARRANTY**

Your Transferable Lifetime Warranty is printed in full on the back cover of this manual. As soon as possible upon receipt of your Windham Weaponry firearm, go online, or call, to activate your warranty. See:

[www.windhamweaponry.com](http://www.windhamweaponry.com)

or call Toll-Free: **855-808 1888**

Follow the Instructions on the website warranty page. Your firearm's warranty will be in effect upon completion of these steps.

## **TABLE OF CONTENTS**

About Your Windham Weaponry Rifle	2
Rifle Features & Controls - Location	2
Familiarize Yourself With Your Rifle	3
Range Safety Checks - Before You Fire!	6
Loading A Magazine	6
Preparing To Fire	7
Chambering A Round From An Open Bolt	7
Chambering A Round From A Closed Bolt	8
Firing The Rifle	8
If The Rifle Stops Firing - Immediate Actions	9
If The Rifle Stops Firing - Remedial Actions	9
Barrel Break-in Procedures	9
Understanding Your Sight Adjustments	10
The Dual Aperture Rear Sight	11
25 Meter Zeroing Procedures	11
Rifle Disassembly, Cleaning & Maintenance	12
Cleaning Bolt, Bolt Carrier & Components	16
A Visual Guide To The WW-15 Rifle	18
Inspection, Cleaning & Lubrication	22
Cleaning The Bore	22
Magazine Disassembly & Cleaning	27
Information on the .308 Caliber Rifle	28
Information on the 7.62x39mm Caliber Rifle	30
Information on the .300 Blackout Caliber Rifle	32
Troubleshooting Problems / Solutions	33
Shipping Rifles For Service	36

## ABOUT YOUR WINDHAM WEAPONRY RIFLE

- This operating manual covers Windham Weaponry models chambered for a wide variety of ammunition calibers. **Be sure that you only use ammunition of the caliber marked on the barrel of your rifle.** These are lightweight, gas operated, air-cooled, magazine fed rifles that operate in semi-automatic mode (meaning that each time the trigger is pulled, a single round will fire, until the magazine is empty).
- On all models, the upper and lower receivers are easily opened for cleaning and inspection. Upper and lower receivers are machined from forged 7075 T6 aircraft aluminum or molded of 40% carbon fiber content polymer composite.
- Most Windham Weaponry models feature fully adjustable rear sights and elevation adjustable front sights. Some models are designed to allow the owner to add their own choice of front and rear sights (e.g. Windham Weaponry SRC & Varmint Exterminator models).
- Barrels on Windham Weaponry models are chrome lined 4150 chrome moly vanadium 11595E steel or 416R grade stainless steel. They are 100% air gauged, bore scoped, head spaced and button rifled - right hand twist with 6 lands and grooves. Refer to barrel markings for twist rate and caliber.
- Windham Weaponry models are supplied with 6 position telescoping buttstocks or fixed style buttstocks.
- Most forends are ribbed and vented to allow heat dissipation.
- All models feature vertical pistol grips and detachable magazines. Standard magazine capacity is 30 rounds (depending on State regulations), but all AR-15/M-16 type magazines of capacities from 5 to 30 rounds will fit and function in Windham Weaponry models.

## RIFLE FEATURES & CONTROLS





# ALWAYS FOLLOW THE RULES OF SAFE GUN HANDLING!

FAMILIARIZE YOURSELF WITH YOUR NEW WINDHAM WEAPONRY RIFLE.  
THEN FOLLOW THESE STEPS TO PREPARE TO USE THE RIFLE.



**ALWAYS ASSUME THE GUN YOU ARE HANDLING IS LOADED.**



**POINT THE RIFLE IN A SAFE DIRECTION!**

Place safety selector lever on **SAFE**. NOTE: If the rifle is not cocked, the safety selector lever cannot be pointed toward **SAFE**.

NOTE: Safety Markings are enhanced in Fig. 1 for easy identification.

Note also: Safety Markings on Carbon Fiber Receivers are icons



rather than words: FIRE =  SAFE = 



Fig. 1

1. To lock bolt open, pull charging handle rearward (A - Fig. 2). Press bottom of bolt catch and allow bolt to move forward until it engages bolt catch (B - Fig. 2). Return charging handle to its forward position.

If you haven't done so before, now place safety selector lever on **SAFE** (as shown in Fig.1)



Fig. 2

2. Remove chamber plug/tool (Fig. 3).

NOTE: The chamber plug/tool should remain in the chamber when the rifle is not in use, or in storage.

Look into the upper receiver and firing chamber to ensure there is no ammunition in the rifle (Fig. 4).

Note: Be sure a magazine is not inserted in the rifle.

3. Once you are sure the firing chamber is empty, and the safety selector lever is on **SAFE**, you can press the upper portion of the bolt catch, or pull the charging handle all the way to the rear and release to allow the bolt to move forward.



Fig. 3



Fig. 4

**THE RIFLE IS NOW "CLEAR".**



4. Using your chamber plug/tool (or a punch) push the takedown pin in as far as it will go. Then pull on the head of the pin (from the right side of the rifle) until it stops (Fig. 5).



Fig. 5

5. Push the front pivot pin in as far as it will go (Fig. 6) - then separate the upper and lower receivers (Fig. 7).



Fig. 6

**NOTE:** On the Carbon Fiber lower receivers, the Takedown Pin is within molded recesses, and will require the Safety Tool, a punch or some similar tool to reach it and push it in.



Fig. 7

6. Pull the charging handle back until it stops. The bolt carrier assembly will come out with it (Fig. 8).

Lift the bolt carrier back and up until it is clear of the upper receiver.

**NOTE:** Observe how the carrier key fits within the slot in the bottom of the charging handle.

7. To remove the charging handle, pull it to the rear until it stops. Then lift the charging handle up, allowing the side tabs to clear the cutouts in the upper receiver (Fig. 9).



Fig. 8

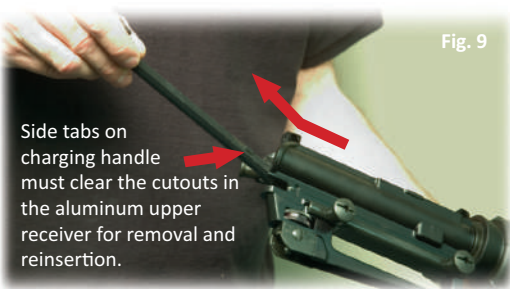
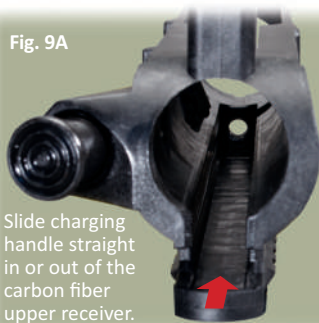

Fig. 9

Side tabs on charging handle must clear the cutouts in the aluminum upper receiver for removal and reinsertion.

Fig. 9A



Slide charging handle straight in or out of the carbon fiber upper receiver.

**NOTE:** On the Carbon Fiber upper receivers, the Charging Handle simply slides straight in or out of the upper receiver. There are no "cutouts" in the charging handle track as in the aluminum receiver (see Fig. 9A)

**CAUTION:** Because of this, if you hold the Carbon Fiber receiver vertically (with barrel up), the Charging Handle and Bolt Carrier can fall out and possibly be damaged.

8. Run a cleaning patch with oil through the barrel. Always pull your cleaning rod from chamber to muzzle (Fig. 10).

9. Run a dry patch through the barrel (again, always from chamber to muzzle).

10. Visually inspect the barrel to make sure it is free of any debris or obstructions.

11. To reassemble your rifle, follow the preceding steps (1 thru 7) in reverse order.

**NOTE:** When installing the charging handle, remember that the tabs on the side of the handle need to drop into corresponding cutouts in the channel within the upper receiver (Fig. 11).

**Remember:** On the Carbon Fiber upper receiver, the charging handle slides straight into the receiver. There are no “cutouts” as in the aluminum receiver.

**NOTE:** When installing the bolt carrier assembly, the bolt must be pulled all the way forward before being inserted in the upper receiver (Fig. 12).

The bolt carrier can then be reinserted in the upper receiver. The gas key must fit into the channel in the charging handle. Then, both charging handle and carrier can slide into receiver (Fig. 13).

With the upper receiver reassembled, it can then be joined to the lower receiver.

**NOTE:** When pivoting the rifle closed, the hammer should be in the cocked (down) position (Fig. 14). The safety can then be moved to the SAFE position.

12. Pull the charging handle to the rear and insert the chamber plug/tool into the chamber. Then ease the charging handle and bolt carrier forward, and latch the charging handle in place.

**YOUR RIFLE IS NOW READY  
TO TAKE TO THE RANGE.**

Fig. 10



Fig. 11



Fig. 12



Fig. 13



Fig. 14

# RANGE SAFETY CHECKS - BEFORE YOU FIRE!

**SAFETY SELECTOR FUNCTION CHECK:** Perform this safety function check to ensure that the safety selector lever works properly.



**ALWAYS ASSUME THE RIFLE YOU ARE HANDLING IS LOADED, AND POINT IT IN A SAFE DIRECTION! WHEN PERFORMING THIS SAFETY CHECK, MAKE SURE THERE IS NO MAGAZINE IN THE RIFLE.**

1. Pull charging handle to the rear, remove chamber plug, and release charging handle. Place selector lever on SAFE. Pull trigger. **HAMMER SHOULD NOT FALL.**
2. Place selector lever in FIRE position, point rifle in a safe direction, and pull trigger. **HAMMER SHOULD FALL.**
3. Hold trigger to the rear, pull charging handle to the rear and release charging handle. Then release pressure on the trigger with a slow, smooth motion, without hesitations or stops, until the trigger is fully forward. **YOU SHOULD HEAR A CLICK AND THE HAMMER SHOULD NOT FALL.**
4. Repeat the FIRE position test **FIVE TIMES** (Step 2 above). The rifle must not malfunction during any of these five tests.



**WARNING: IF THE RIFLE MALFUNCTIONS DURING ANY OF THESE FIVE TESTS, CONTACT THE FACTORY FOR TECHNICAL SUPPORT. Call Toll Free: 1-855-808-1888**

## LOADING A MAGAZINE

1. **USE ONLY QUALITY AMMUNITION THAT IS APPROPRIATE TO THE CALIBER MARKED ON THE BARREL OF YOUR RIFLE.** Brass cased ammunition is recommended.



**CAUTION! DO NOT USE AMMUNITION THAT IS DENTED, SCRATCHED, CORRODED, OR DAMAGED.**

2. Insert a cartridge between the feed lips of the magazine with the bullet tip forward. Push the cartridge down until it is held by the magazine feed lips (as shown Arrow A - Fig. 15).
3. Then slide the cartridge backward to seat it against the inside back of the magazine (Arrow B - Fig. 15). Place the next cartridge on top of the previous one and repeat steps 2 & 3 until desired number of cartridges are loaded into the magazine (Fig. 16).



**CAUTION! DO NOT LOAD LIVE AMMUNITION INTO YOUR MAGAZINE UNTIL YOU ARE READY TO SHOOT.**

**NOTE:** AR15/M16 type magazines will hold various capacities of ammunition - but all function in the same manner. Do not try to force more cartridges into a magazine than it was designed to hold.

**Note also that .223/5.56 magazines can also be used with .300 Blackout ammunition in rifles chambered & barreled for that caliber. Always be sure the ammunition you use matches the caliber marking on the barrel of your rifle. .300 Blackout ammunition can cause catastrophic failure when used in a 5.56 chamber.**

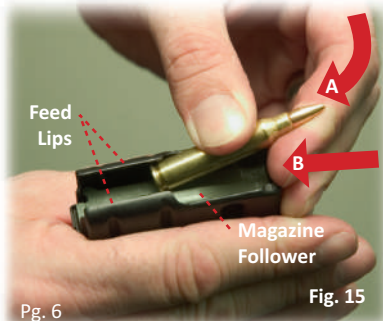



## PREPARING TO FIRE



**ALWAYS PRACTICE SAFE FIREARMS HANDLING! ASSUME THE RIFLE YOU ARE HANDLING IS LOADED!**  
**ALWAYS USE EYE AND EAR PROTECTION FOR SAFETY WHEN SHOOTING!**

Pull charging handle to the rear and lock bolt carrier back by depressing the bottom of the bolt catch. Slide the charging handle forward until it latches into the upper receiver. Move the safety selector to the SAFE position (Fig. 17).



## INSERTING A MAGAZINE

Push a magazine up into the magazine well until the magazine catch engages and holds the magazine in place (Fig. 18). To ensure that the magazine is seated completely in the magazine well, slap up on the bottom of the magazine (Fig. 18A) and then pull down on the magazine.



## CHAMBERING A ROUND FROM AN OPEN BOLT

With a magazine inserted, press upper portion of the bolt catch (Fig. 19). Bolt should spring forward - chambering a round. Or, you can pull back on the charging handle and release.

Then tap the forward assist to ensure bolt is fully forward and locked (Fig. 20).



## CHAMBERING A ROUND FROM A CLOSED BOLT



**KEEP YOUR FINGER OFF THE TRIGGER UNTIL YOU ARE READY TO FIRE THE RIFLE.**

Insert a loaded magazine into the magazine well until the magazine catch engages and holds the magazine. Slap up on the bottom of the magazine to ensure it is seated correctly.

Pull charging handle fully to the rear (Fig. 21).

Release charging handle. Never “ride” the charging handle forward. The charging handle and bolt assembly should slide forward from the pressure of the action spring to chamber a round (Fig. 22).

Then tap the forward assist to ensure bolt is fully forward and locked (Fig. 23). Now move the safety selector to the SAFE position.



The rifle is now loaded, a round is chambered, the safety selector lever should be in the safe position.

## FIRING THE RIFLE



**CAUTION! ALWAYS POINT THE MUZZLE IN A SAFE DIRECTION!**

**To fire the rifle:**

1. Aim at your target.
2. Move safety selector lever from SAFE to FIRE (Fig. 24).
3. Squeeze the trigger – release trigger pressure.
4. The rifle will eject the spent cartridge and chamber another in preparation for the next shot. This is called firing in “semi-automatic mode”. One round will be fired with each pull of the trigger, and the rifle will automatically reload, until the magazine is empty.



**NOTE:** After the last round is fired, the bolt carrier will lock in the rear position. You can then push the magazine release button to drop out the empty magazine\*, insert a fresh magazine, release the bolt catch, and a new round will automatically be chambered in preparation for the next shot.

**If you stop firing the rifle before the magazine is empty:**

1. Move safety to SAFE position.
2. Remove magazine.
3. Lock bolt to the rear (to remove live round from the chamber).
4. Visually inspect the chamber to ensure that it is empty.

# IF THE RIFLE STOPS FIRING - IMMEDIATE ACTIONS

## IF THE RIFLE FAILS TO FIRE WHEN THE TRIGGER IS SQUEEZED...

1. Keep the rifle safely pointed downrange for 30 seconds.
2. Remove the magazine.
3. Lock the bolt to the rear (take note if a live round is ejected).
4. Place safety selector in safe position.
5. Visually inspect the chamber to ensure that the chamber is empty!

A. If a live round was ejected when clearing the rifle, inspect the round for evidence of possible ammo failure.

B. If a live round was not ejected, reinsert the magazine in the magazine well until the magazine catch engages and holds the magazine securely in place. Press bolt catch to chamber a round and resume firing.



**IF YOU HEAR A NOTICEABLE DIFFERENCE IN SOUND OR RECOIL DURING FIRING, STOP FIRING! EITHER CONDITION COULD INDICATE AN INCOMPLETE POWDER BURN AND/OR A STUCK BULLET IN THE BORE.\***

1. Remove the magazine.
2. Lock the bolt to the rear.
3. Place safety selector in safe position and visually check that the chamber is empty.
4. Visually inspect the bore or insert a cleaning rod in the bore to ensure there is not a bullet stuck in the bore.

\*If a bullet is stuck in the barrel, do not attempt to remove it. Contact Windham Weaponry for Technical Support. Call: 1-855-808-1888

## IF THE RIFLE STOPS FIRING - REMEDIAL ACTIONS



**WARNING!** If your rifle stops firing with a live round in the chamber of a hot barrel, remove the round FAST! However, if you cannot remove it within 10 seconds, remove the magazine and wait 15 minutes with the rifle pointing in a safe direction! This way you won't get hurt by a possible round "cooking off" (meaning a round may detonate unexpectedly from being exposed to the heat of the rifle's firing chamber). Always be sure to keep your face away from the ejection port while clearing a hot chamber.

If your rifle still fails to fire, check the troubleshooting section of this manual.

## BARREL BREAK-IN PROCEDURES

### CHROME LINED BARRELS/MELONITE QPQ Finish

First run a dry patch down the bore to remove any oil left in the barrel as it came from the factory. Barrel Break-in Procedures for these Barrels (regardless of caliber) require firing approximately 100 rounds of good quality brass cased ammunition. Then clean the barrel thoroughly according to the instructions in this Operators Manual (Page 22), and your rifle will be ready for the range or the hunt.

### STAINLESS STEEL BARRELS

First run a dry patch down the bore to remove any oil left in the barrel as it came from the factory. Fire one shot, then clean the barrel - repeat this one shot & clean process 5 times. Fire three shots, then clean the barrel. Fire five shots, then clean the barrel, and your stainless steel barrel will be well broken in.

# UNDERSTANDING YOUR SIGHT ADJUSTMENTS

## THE FRONT SIGHT IS ADJUSTABLE FOR ELEVATION

**FRONT SIGHT ADJUSTMENT:** To adjust elevation, depress detent and rotate post using a firing pin, punch or the specifically designed front sight adjustment tool. To raise strike of bullet, rotate post in the direction of arrow marked up (clockwise) (Fig. 26).

Reverse the direction of rotation to lower strike of bullet. Each of the 4 graduations (notches) moves the point of impact of bullet as indicated below.

Elevation adjustments at front sight post (A2 four position) - one "click" equals:

### For Carbine Sight Radius\*:

DISTANCE	IMPACT
25 meters	1.2 cm (1/2")
100 meters	4.8 cm (1 7/8")
200 meters	9.6 cm (3 3/4")
300 meters	14.4 cm (5 3/4")

### For Rifle Sight Radius\*:

DISTANCE	IMPACT
25 meters	0.83 cm (3/8")
100 meters	3.5 cm (1 3/8")
200 meters	6.5 cm (2 5/8")
300 meters	10.0 cm (4")

\*Sighting Data from Army Marksmanship manual.

25 meters = 27 yards + 1 ft. (82 ft.)      100 meters = 109 yards + 1 ft. (328 ft.)

**NOTE:** On Carbon Fiber Upper Receivers, the Picatinny rail is .040" higher than on aluminum receivers. It may therefore be necessary to use a .040" taller front sight post if raising your existing front sight post doesn't allow sighting in accurately. Taller front sight posts are available on our website: [www.windhamweaponry.com](http://www.windhamweaponry.com) (Part number: 9349056-MOD)

## THE REAR SIGHT IS ADJUSTABLE FOR WINDAGE AND ELEVATION

Turning the windage knob clockwise will move bullet impact to the right. Turning the windage knob counter-clockwise will move bullet impact to the left (Fig. 27).

Once the rifle is zeroed, the rear sight is adjustable for elevation when firing at distances of 300 - 600 meters (A4 sights) or 300 - 800 meters (A2 sights).

Windage adjustments - one "click" equals:

### For Carbine Sight Radius\*:

DISTANCE	IMPACT
25 meters	0.5 cm (1/4")
100 meters	2.75 cm (1")
200 meters	5.5 cm (2 1/4")
300 meters	8.5 cm (3 1/4")

### For Rifle Sight Radius\*:

DISTANCE	IMPACT
25 meters	0.33 cm (1/8")
100 meters	1.5 cm (1/2")
200 meters	2.5 cm (1")
300 meters	4.0 cm (1 1/2")

\*All the above values have been rounded off. To remember your correct zero windage, note location of windage scale and windage knob pointer (heavy mark on outside of knob). Once you have established your correct zero windage leave your windage scale and windage knob pointer on these settings at all times.

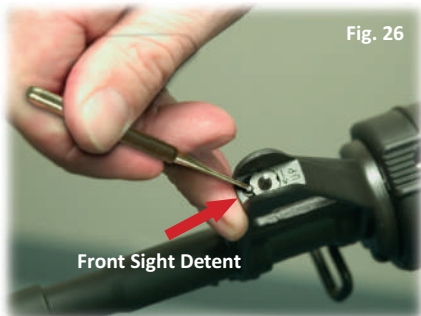

Fig. 26

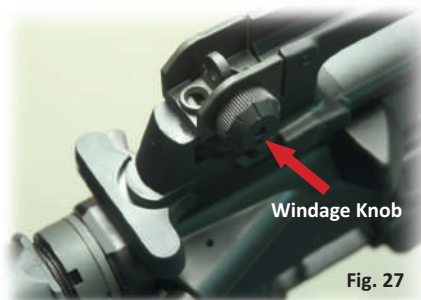
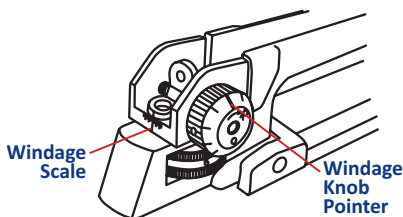

Fig. 27





# THE DUAL APERTURE REAR SIGHT

## ADJUSTABLE FOR ELEVATION & WINDAGE

**SHORT RANGE** - The "02" (larger) aperture is used for 0-200 meters range. As shown below, the sight is set for 0 - 200 meters. This larger aperture is only used when the rear sight is all the way down. In other words, the 300-meter mark is aligned with the mark on the left side of the receiver (Fig. 28).

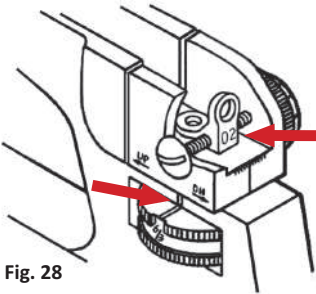

Fig. 28

Short Range (0-200 meters)

**NORMAL RANGE** - The aperture is unmarked and used for most firing situations. It is used in conjunction with the elevation knob for 300, 400, 500, 600, 700, and 800 meter targets with A2 sights (Fig. 29).

With A4 carry handle sights, ranges are 300, 400, 500, 600 meters.

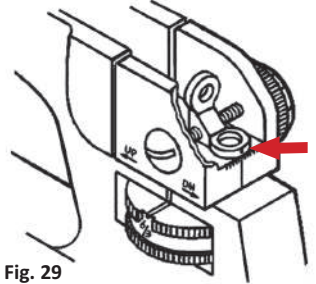

Fig. 29

Normal Range - A2 Sights: 300-800 meters  
A4 Sights: 300-600 meters

A2 sights - 1 min. elevation  
1/2 min. windage

A4 sights - 1/2 min. elevation  
1/2 min. windage

A2 elevation wheels  
are marked 8/3  
A4 elevation wheels  
are marked 6/3

## 25 METER ZEROING PROCEDURES

By following the steps below and establishing a zero at 25 meters, your rifle sights will be set with a 300-meter battlesight (these instructions apply to a 16" Bbl. Carbine).

1. Do not move front sight post at this time. It was set at the factory and should be very close to your zero.
2. The unmarked (smaller) aperture should be flipped up - see figure 29 above.
3. Center the rear sight aperture by turning the windage knob left or right (this is called "mechanical zero windage").
4. Rotate elevation knob in the down direction (counter-clockwise - Fig. 30) to bottom out the rear sight. This is called "mechanical zero elevation" for the rear sight on all Carbines, and applies whether you have the A2 Sight (Fixed Carry Handle Carbine) or the A4 Sight (Removable Carry Handle).



Fig. 30

On rifles with a rifle length sighting radius like our 20 inch Gov't Model, you move the rear elevation up one click from the bottomed position for A2 Sights and two clicks to the "Z" mark on the A4 Carry Handle Sights.

**From this point on, the rear sight elevation knob should not be moved. Any changes in elevation required in the following zeroing steps are made to the front sight post only.**

5. Carefully aim and fire at the center of the target bulls-eye.
6. If your shot group is not in the center of the bulls-eye, calculate the required "clicks" necessary to move your next shot group into the bulls-eye using the elevation and windage values in the "Understanding Your Sight Adjustment" section on the previous page. Remember that any changes in elevation are made by moving the front sight post only.
  - A. In order to raise your next shot group, rotate the front sight post clockwise. In order to lower your next shot group, rotate the front sight post counterclockwise.
  - B. Changes in windage are made with the windage knob. To move the shot group to the left, turn the windage knob counterclockwise. To move the shot group to the right, turn the windage knob clockwise.

## 25 METER ZEROING PROCEDURES (continued)

7. Carefully aim and fire another group at the center of the target bulls-eye.

8. Repeat steps 5 and 6, if required.

9. When your group is on target, your sight is now "calibrated" for battlesight zero. If your rifle has a rifle length sight radius, move the elevation knob back down to the 6/3 position for A4 removable carry handles, or 8/3 for A2s fixed carry handles. The range scale's 300-meter mark should now be aligned with the corresponding index above the elevation wheel.



**ONCE YOU ARE FINISHED  
AT THE RANGE...**

1. Clear the rifle to ensure the chamber is empty (Fig. 31).
2. Place safety in the safe position.
3. Pull the charging handle to the rear and insert the chamber plug/tool into the chamber. Then ease the charging handle and bolt forward and latch in place (Fig. 32).

**THE RIFLE IS NOW SAFE TO TRANSPORT  
FROM THE RANGE.**



Fig. 31



Fig. 32

## RIFLE DISASSEMBLY, CLEANING & MAINTENANCE



**ALWAYS FOLLOW THE RULES OF SAFE GUN HANDLING!  
ALWAYS ASSUME THE GUN YOU ARE HANDLING  
IS LOADED.**



**POINT THE RIFLE IN A SAFE DIRECTION!**

Place the safety selector lever on **SAFE** (Fig.33).

**NOTE:** If the rifle is not cocked, the safety selector lever cannot be pointed toward **SAFE**.



Fig. 33

### A NOTE REGARDING CARBON FIBER RECEIVERS:

Because of very minor dimensional differences, you cannot assemble an Aluminum Upper Receiver Assembly onto a Carbon Fiber Lower Receiver Assembly. Use of force to assemble these components will cause damage. **Conversely**, do not attempt to attach a Carbon Fiber Upper Receiver Assembly onto an Aluminum Lower Receiver Assembly. There are also minor differences between the Carbon Fiber model's barrel nut and that of Aluminum receiver models. Barrel Nut threading is different on Carbon Fiber models, and we also use Loctite on Carbon Fiber Barrel Nuts, so attempting to remove a Carbon Fiber Barrel Nut can cause damage to the Carbon Fiber Upper Receiver, and may void your warranty. This Carbon Fiber Barrel Nut difference limits the number of accessory forends that can be mounted to the Carbon Fiber rifle. Call Windham Weaponry Technical Assistance if you have questions on this.

# RIFLE DISASSEMBLY, CLEANING & MAINTENANCE (Continued)

1. To lock the bolt open, pull the charging handle rearward (A - Fig. 34). Press the bottom of the bolt catch and allow the bolt to move forward until it engages the bolt catch (B - Fig. 34). Return the charging handle to its forward position.

If you haven't done so before, place the safety selector lever on **SAFE**.



Fig. 34



Fig. 35

2. Remove the chamber plug/tool (Fig. 35).

Look into the upper receiver and firing chamber to ensure there is no ammunition in the rifle (Fig. 36).

**NOTE:** Be sure a magazine is not inserted in the rifle.



Fig. 36

3. Once you are sure the firing chamber is empty, and the safety selector lever is on **SAFE**, you can press the upper portion of the bolt catch, or pull the charging handle all the way to the rear and release to allow the bolt to move forward (Fig 37).

**THE RIFLE IS NOW "CLEAR".**



Fig. 37

4. Using your chamber plug/tool (or a punch) push the takedown pin in as far as it will go. Then pull on the head of the pin (from the right side of the rifle) until it stops (Fig. 38).

5. Push the pivot pin in as far as it will go (Fig. 39) - then separate the upper and lower receivers (Fig. 40).

**REMEMBER:** Carbon Fiber lower receivers will require a tool to reach the Takedown Pin.



Fig. 38

## RIFLE DISASSEMBLY, CLEANING & MAINTENANCE (Continued)

Fig. 39



6. Pull the charging handle back. The bolt carrier assembly will come out with it (Fig. 41).

Lift the bolt carrier back and up until it is clear of the upper receiver.



Fig. 40



Fig. 41

**NOTE:** Observe how the carrier key fits within the slot in the bottom of the charging handle (Fig. 42).



Fig. 42

7. To remove charging handle, pull it to the rear until its side tabs clear the cutouts in the upper receiver (Fig. 43).

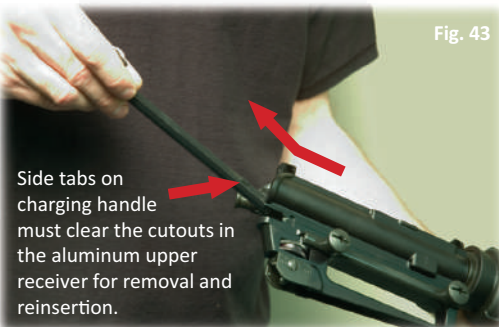

Fig. 43

**REMEMBER:** On the Carbon Fiber upper receivers, the Charging Handle simply slides straight into the receiver. There are no “cutouts” as in the aluminum receiver. The Charging Handle can fall out and potentially be damaged.



## RIFLE DISASSEMBLY, CLEANING & MAINTENANCE (Continued)

8. Remove the firing pin retaining pin (Fig. 44)

**NOTE:** Do not open or close the split end of the firing pin retaining pin, and **NEVER** substitute a common cotter pin on reassembly.



Fig. 44

9. Push the bolt in to locked position within the bolt carrier (Fig. 45).



Fig. 45



Fig. 46

10. Drop the firing pin out of rear of the bolt carrier (Fig. 46).

11. With the bolt pushed into the locked position, remove the cam pin by rotating 1/4 turn and lifting out (Fig. 47).

**NOTE:** If you have a .308 rifle, the cam pin pulls straight out. See .308 Addendum Section.



Fig. 47

12. Remove the bolt assembly from the bolt carrier by pulling it straight out (Fig. 48).



Fig. 48

# RIFLE DISASSEMBLY, CLEANING & MAINTENANCE (Continued)

## CLEANING THE BOLT, BOLT CARRIER & COMPONENTS

13. Once the bolt carrier has been disassembled...

A. Clean the gas key on top of the bolt carrier with a pipe cleaner or Q-tip (Fig. 49). Lightly oil the gas key (Fig. 50). Clean carbon and powder residue from vent holes and outer and inner surfaces of the bolt carrier. Use a bore brush - wet with CLP - to clean carbon and powder residue from around the gas tube.

B. Clean and inspect the bolt, cam pin, firing pin and firing pin retaining pin thoroughly. Clean the bolt locking lugs, bolt rings, firing pin, firing pin hole and cam pin (Fig. 51).

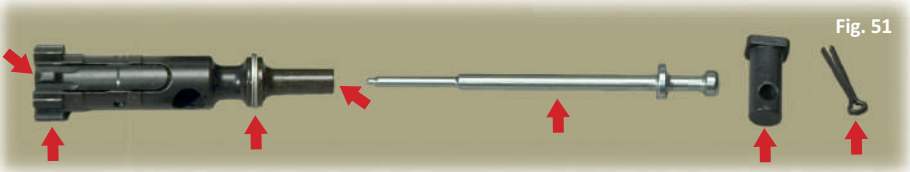
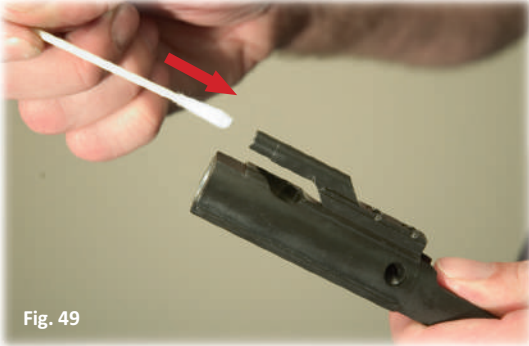

14. Remove extractor pin by pushing it out with the tip of the firing pin or a punch. Take care not to damage the firing pin, or lose the extractor pin (Fig. 52).

15. Remove the extractor with its spring, insert and o-ring (Fig. 53).

**CAUTION:** It is unlikely, but if the extractor spring should pop out of its recess, reset the spring by pressing it back in its recess with a punch as shown in Fig. 55 (on next page).



# RIFLE DISASSEMBLY, CLEANING & MAINTENANCE (Continued)

## CLEANING THE BOLT, BOLT CARRIER & COMPONENTS (continued)

16. Check the extractor, extractor spring, insert and o-ring. If the extractor is chipped, or if the lip that engages the cartridge rim has broken edges, the extractor should be replaced. Check that the rubber insert is inside the extractor spring. Clean off any carbon buildup or powder residue (Fig. 54). Use CLP to clean any carbon buildup or powder residue in the extractor pocket/channel of the bolt. Use a pipe cleaner and CLP to clean the firing pin channel of carbon buildup and powder residue.

**NOTE\*:** Extractor assembly has a rubber insert within the spring. Be sure not to lose it. If the spring comes loose, put the large end of spring in the extractor and seat it with a punch (Fig.55).

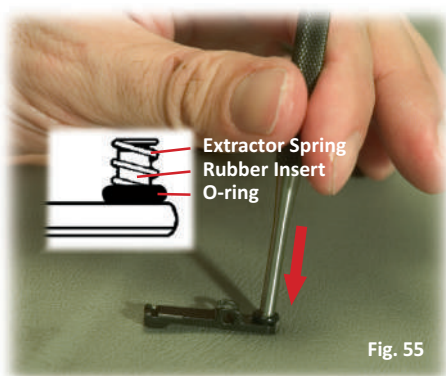

17. Reinsert extractor in bolt (Fig. 56). Press extractor down to reinsert extractor pin (Fig. 57).

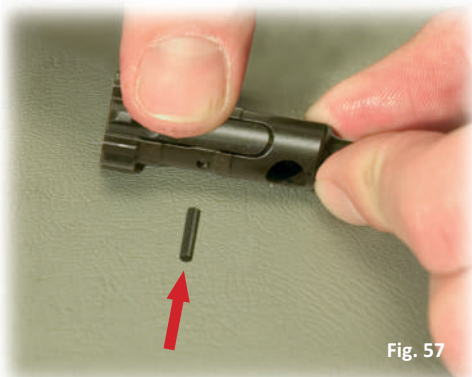

## LUBRICATING THE EJECTOR

**NOTE:** Windham Weaponry does not recommend disassembly of the ejector for cleaning. You can ensure that your rifle ejects empty cases efficiently by following these lubrication steps on a regular basis.

18. With the bolt removed from the bolt carrier, hold it in your hand as shown with bolt face and ejector up. Lubricate the ejector with a few drops of CLP (Fig. 58).

*\*Components in .308 and 7.62 rifles differ slightly. There is no rubber insert utilized in the .308 and 6.5 Creedmoor. There is no o-ring utilized in the 7.62x39, .450 Thumper, or .224 Valkyrie rifle.*



# RIFLE DISASSEMBLY, CLEANING & MAINTENANCE will continue on Page 20





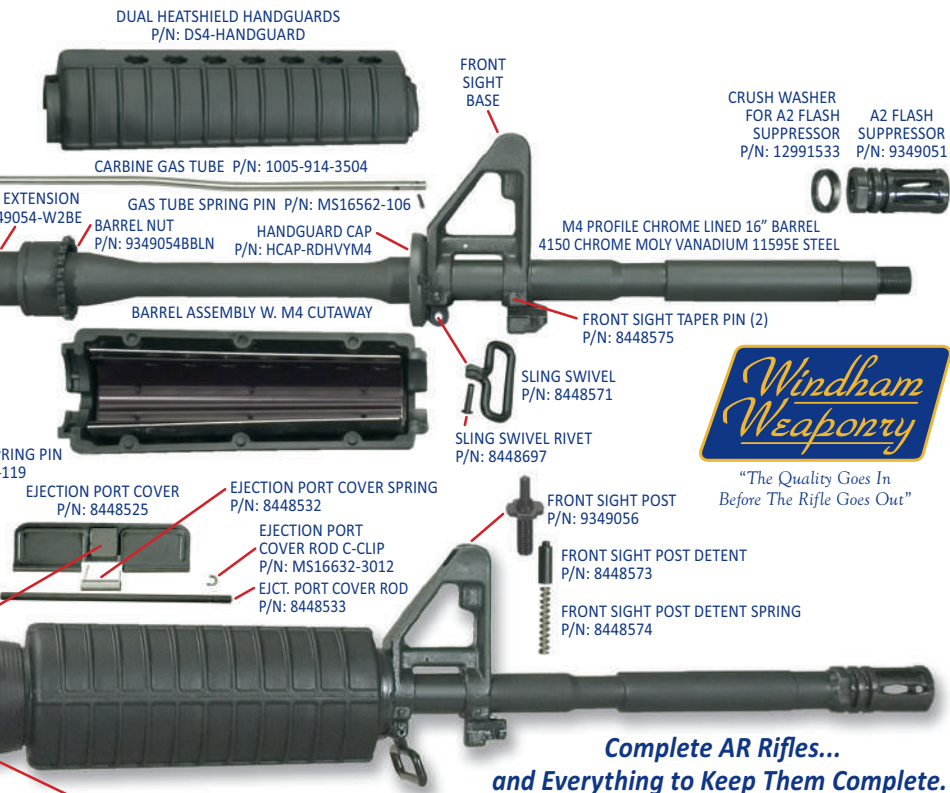

"The Quality Goes In Before The Rifle Goes Out"

Complete AR Rifles...  
and Everything to Keep Them Complete.

# A VISUAL GUIDE TO THE WW-15 RIFLE

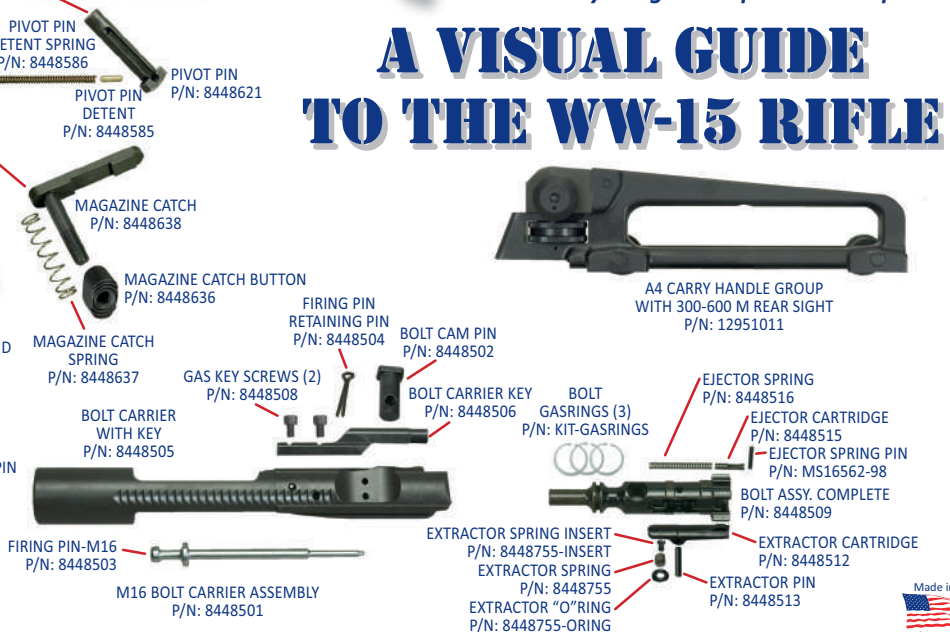

Order Online: [www.windhamweaponry.com](http://www.windhamweaponry.com)

# RIFLE DISASSEMBLY, CLEANING & MAINTENANCE (Continued)

## LUBRICATING THE EJECTOR (continued):

19. Place an empty .223 case, or a dummy round, under the lip of the extractor. With a rocking motion, press the case down against the ejector. The ejector is spring loaded, so you will feel some resistance. Press on the case until it stops against the bolt face. Rock the case back and forth several times to work the CLP lubricant into the ejector and its spring. Relubricate the ejector, and repeat the rocking motion several times. Once the spring action of the ejector is smooth and strong, dry off any excess lubricant (Fig. 59).

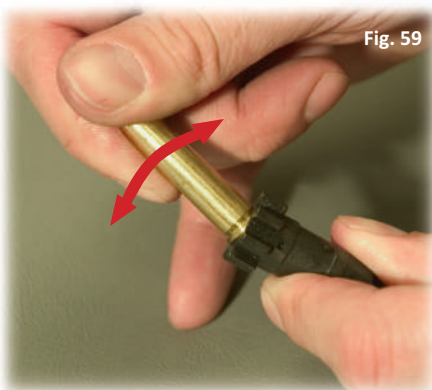

Fig. 59

## INSPECTIONS BEFORE REASSEMBLY:

**CAUTION:** The bolt should not have any cracks or fractures - especially in the cam pin hole area. The bolt face should not have any pitting - especially around the firing pin hole. If this pitting is found, the bolt must be replaced.

- The cam pin should not be cracked or excessively worn. If so, replace it.

**NOTE:** In as little as 100 rounds, normal wear on a Cam Pin can show an indented pattern where the Bolt and Cam Pin interact. This is not a crack, or a dangerous situation. Real cracks in the Cam Pin however, can cause a catastrophic failure.



**WARNING: IF THE CAM PIN IS MISSING,  
DO NOT FIRE THE RIFLE!  
IT WILL HAVE A CATASTROPHIC FAILURE!**

Cam Pin  
showing  
normal wear.



- The firing pin should not be worn, bent, or too blunt or too sharp.

If the firing pin retaining pin is bent or worn, replace it. NEVER spread the legs of the firing pin retaining pin apart, and never use a common cotter pin as a substitute (Fig. 60).

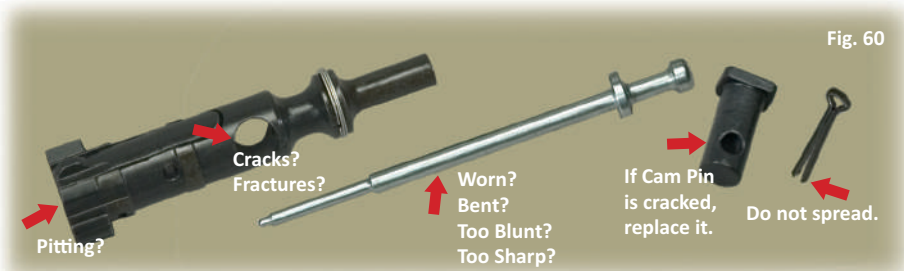

Fig. 60

## LUBRICATION BEFORE REASSEMBLY:

**BOLT CARRIER GROUP:** Apply a LIGHT COATING OF CLP to firing pin and firing pin recess (hole) in bolt, the extractor and its pin, and inner surfaces of the bolt carrier. GENEROUSLY LUBRICATE the outside areas of the bolt body and cam pin, and the slide and cam pin areas of the bolt carrier.

**STAGGER GAS RINGS:** Gaps in the 3 gas rings should be evenly spaced around the bolt body (120° apart) to stop gas loss (Fig. 61).



Fig. 61

# RIFLE DISASSEMBLY, CLEANING & MAINTENANCE (Continued)

## NOW INSERT BOLT INTO CARRIER:

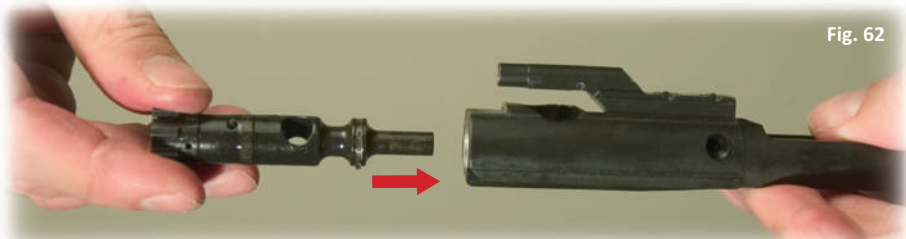

Fig. 62



**WARNING:** Regarding swapping bolts between rifles, while Windham Weaponry rifles and bolts are machined with great care, and are interchangeable with other Windham Weaponry bolts, we do not recommend exchanging bolts - particularly those from other manufacturers, without first checking for proper headspacing with a Field Gauge or Go/No-Go Gauge for .223 Rem./5.56mm NATO.

### INSERT CAM PIN:

Insert cam pin into carrier and hole in bolt body (Fig. 63).

**NOTE:** The cam pin should only fit into the bolt from one side. If it doesn't slip in easily, turn bolt body 180° within the carrier and try again. After cam pin is inserted, turn it 90°. This allows for the insertion of the firing pin.

### INSERT FIRING PIN:

Drop firing pin into back end of bolt carrier (Fig. 64) and seat by pushing in all the way (Fig. 65).

### INSERT FIRING PIN RETAINING PIN:

Insert firing pin retaining pin into the firing pin retaining pin hole in the side of the carrier as shown (Fig.66).

**NOTE:** In the cutaway drawing, the firing pin retaining pin sits behind the large shoulder of the firing pin. The test for correct positioning is that the firing pin should not fall out when bolt carrier group is turned upside down.

Now that the bolt carrier is fully reassembled, move the bolt in and out of the carrier to ensure that the cam pin retains the bolt in the carrier and that the cam pin moves freely in the cam pin track.

Tap the rear of the bolt carrier on a solid surface to ensure that the firing pin and its retaining pin is installed properly.

Now lightly lubricate the bolt carrier assembly and charging handle assembly.



Fig. 63



Fig. 64



Fig. 65



Fig. 66

# RIFLE DISASSEMBLY, CLEANING & MAINTENANCE (Continued)

These steps have been adapted from the US Gov't. Manual and involve the use of the standard issue M16 cleaning kit. You can achieve comparable results with any high quality rifle cleaning kit. Be sure your kit includes a quality cleaning rod; patch holder; cotton flannel bore patches; pipe cleaners; a small toothbrush; brass wire bristle bore and chamber brushes; and a Cleaner/Lubricant/Preservative (CLP). If you use an ammonia based solvent while cleaning a chrome lined barrel, do not let it sit in the bore for more than 10 minutes. This will cause premature deterioration of the chrome lining. The toothbrush is for cleaning parts and dislodging dirt. Pipe cleaners or Q-tips are for cleaning the gas key, gas tube and other hard to reach areas.

## CLEANING THE BORE:

**ALWAYS CLEAN FROM CHAMBER TOWARDS THE MUZZLE AND ALWAYS PULL THE BORE BRUSH THROUGH THE BORE**

The bore of your Windham Weaponry rifle has lands and grooves called rifling. Rifling makes the bullet spin very fast as it moves down the bore and down range. Because it twists so quickly, it is difficult to push a new, stiff bore brush through the bore. You will find it much easier to pull your bore brush through the bore. Also, because the brush will clean better if the bristles follow the grooves (called tracking), you want the bore brush to be allowed to turn as you pull it through.

1. Swab out the bore with a patch moistened with CLP.

2. If using a multi-piece military cleaning rod, attach three rod sections together but leave each one about two turns short of being tight (Fig. 67).

3. Attach the bore brush. The rod and bore brush will twist as you pull it through - following the path of the rifling. NEVER reverse the direction of the bore brush while it is in the bore.

4. Point the muzzle down. Hold the upper receiver in one hand while inserting the end of the rod without the brush into the firing chamber. Let the rod fall straight through the bore. About 2-3 inches will be sticking out of the muzzle at this point.

5. Attach the handle section of the cleaning rod to the end of the rod sticking out of the muzzle (Fig. 68).

6. Pull the brush through the bore and out the muzzle.

7. After one pull, take off the handle section and repeat the process.

8. Send a patch through the bore once in a while to help clean out the crud that the brush is getting loose. You can use the same technique as described above to save time. Just replace the bore brush with the rod tip (patch holder) and a wet patch. Drop it through. You won't need to attach the handle to pull only a patch through. If you leave the rods loose again, the patch will "track" in the rifling as before. Remember - always have the bore wet with cleaner before trying to pull a brush through.

**NOTE:** You can safely use any cleaning, lubricating or powder/copper solvents on Carbon Fiber receiver rifles that you would on rifles with aluminum receivers.





# RIFLE DISASSEMBLY, CLEANING & MAINTENANCE (Continued)

## CLEANING THE UPPER RECEIVER

1. Using CLP, clean all areas of the upper receiver (inside and out) to remove powder fouling, corrosion and dirt.

**NOTE:** Never use a wire brush or any type of abrasive to clean the aluminum upper receiver - you could scratch and damage the anodized finish. A toothbrush can be effective to loosen dirt buildup, and won't scratch the receiver.

2. Clean the chamber by moistening the larger chamber brush with CLP, and use plunge strokes and clockwise rotations (Fig. 69).

**NOTE:** Do not push the larger portion of the chamber brush into the bore.

3. Swab out the chamber and bore to remove contaminated CLP, carbon buildup and powder fouling. Wipe all components clean and dry, and inspect for any excessive wear, corrosion or mechanical damage. Replace any worn or defective parts before your next shooting session. Contact Windham Weaponry toll free at 1-855-808-1888 for parts needs, or consult with a qualified gunsmith.



## REMOVING THE HANDGUARDS

1. To remove the handguards, pull delta ring towards you, gently tap handguards on the edge of your work surface on the seam where the handguards come together (Fig. 70). The handguards will separate and can now be removed (Fig. 71).

**NOTE:** On VEX & .308 Hunter Models with Laminate Wooden Forends, the Handguards are split vertically rather than horizontally. Removal procedure is similar to that shown below.

If your rifle has a free floating handguard, it is not recommended to remove it for barrel cleaning. You can clean/lubricate the barrel through venting slots or from the open end with a cleaning rod and a wet patch.



## LUBRICATION OF UPPER RECEIVER & BARREL

1. **UPPER RECEIVER:** Lightly lubricate the inside of upper receiver, the bore and chamber (using the cleaning rod and a patch), the outer surfaces of the barrel and front sight, and surfaces under the handguards. Take special care to clean and lubricate the locking lugs just outside the firing chamber. The forward assist should also be lightly lubed inside the receiver and checked for function (Fig. 72).

2. **FRONT SIGHT DETENT:** Depress the detent, and apply two or three drops of CLP to it. Depress the detent several times to work the lubricant down into the spring (Fig. 73).

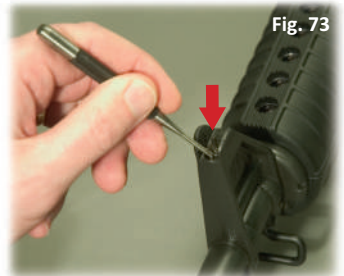

# RIFLE DISASSEMBLY, CLEANING & MAINTENANCE (Continued)

## LUBRICATION OF UPPER RECEIVER & BARREL (continued)

### 3. ADJUSTABLE REAR SIGHT:

**NOTE:** Make a note of how far you move the sights so they can be returned to their original position after completing this lubrication procedure (Fig. 74).

**MOVING PARTS:** Use one or two drops of CLP. Rotate these parts to ensure lubricant is spread evenly above and below the elevation knob / elevation screw shaft / windage knob (maximum five clicks left or right) / windage screw / detent holes.

**ELEVATION SCREW SHAFT:** Remove A4 carry handle to lubricate the elevation screw (or, if you have an A2 fixed carry handle upper receiver, look inside the upper). Put two or three drops of CLP on bottom of elevation screw shaft and in elevation detent spring hole. Rotate the elevation dial back and forth a few times while keeping upper receiver upside down.

**AFTER LUBING REAR SIGHT:** Reset your correct zero windage and your battlesight zero. Refer to the section within this manual about setting battlesight zero. Notice the rear sight comes down when the "6/3 or 8/3" is aligned with the mark on the left side of the receiver. You will feel a "click" when the "6/3 or 8/3" first lines up with the mark. Carry your rifle with the "6/3 or 8/3" aligned with the mark. Keep the sight on 300 meters to keep dirt and water out of sight mechanism and protect the sight from damage.

**IF YOU GET THE REAR SIGHT WET:** Clean it as soon as possible to avoid the onset of rust and corrosion.

### Adjustable Rear Sight on A4 Removable Carry Handle

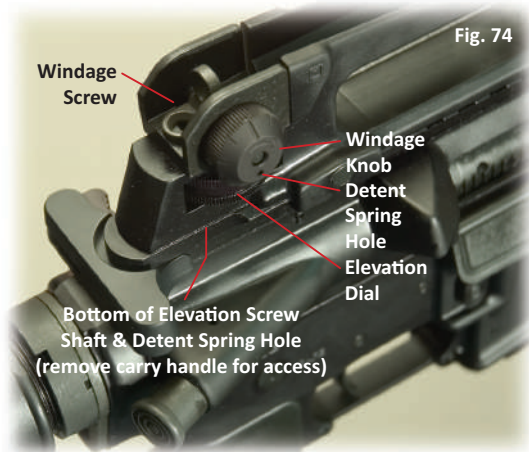

Fig. 74

## REINSTALLING THE HANDGUARDS

1. Insert the first half of the handguard into the handguard cap. Then pull the delta ring back and insert rear part of the handguard onto the delta ring as shown (Fig. 75).



Fig. 75

2. Now insert the second half of the handguard into the handguard cap and pull back the delta ring and slide the rear of the handguard onto the delta ring as shown (Fig. 76).



Fig. 76

3. Then squeeze the rear of the handguard halves as shown until they snap into the delta ring. (Fig.77).

**NOTE:** The two halves of standard issue rifle and carbine length handguards are identical, and so can be installed either on top or bottom. Remember that Wood Forend Sets are split vertically, not horizontally, and are mirror image parts. When re-installing, position the cooling vents on the upper side of the barrel.



Fig. 77

# RIFLE DISASSEMBLY, CLEANING & MAINTENANCE (Continued)

## INSTALLING THE CHARGING HANDLE

1. **INSTALL THE CHARGING HANDLE:** Insert the charging handle into the upper receiver and align the tabs on the charging handle with the corresponding slots in the upper receiver.

Then push the charging handle down into the charging handle groove and slide it part way forward (Fig. 78).

**REMEMBER:** On Carbon Fiber upper receivers, the Charging Handle simply slides straight into the receiver - there are no "cutouts" as in the aluminum upper receiver.



Fig. 78

2. **INSTALL THE BOLT CARRIER:** Pull the bolt to the "out" position in the carrier. As you install the bolt carrier, align the gas key with the channel in the charging handle. Then push the bolt carrier and charging handle all the way forward until the bolt carrier is flush with the back of the upper receiver and the charging handle latches in place (Fig. 79).



Fig. 79

## LOWER RECEIVER DISASSEMBLY

1. With the hammer cocked, depress buffer retainer with chamber plug tool or punch to release buffer and spring (Fig. 80).

**NOTE:** Hammer must be cocked to allow clearance for removal of buffer and spring.

**CAUTION:** The buffer is under tension from the action spring.



Fig. 80

2. Pull buffer and action spring out for cleaning (Fig. 81).

**NOTE:** Windham Weaponry does not recommend any further disassembly of rifle components or subsystems. If you need further service or parts, consult the factory or a qualified gunsmith.



Fig. 81

Fig. 82



# RIFLE DISASSEMBLY, CLEANING & MAINTENANCE (Continued)

## CLEANING THE LOWER RECEIVER

1. Using CLP, or a quality gun cleaner, clean all areas on the lower receiver of any powder fouling, corrosion and dirt. Use of a toothbrush will avoid scratching the finish - **NEVER** use a wire brush.

2. Clean any dirt from the trigger mechanism. Carefully clean the magazine release button and the cavity for the magazine catch on the left side of the receiver. Inspect and clean the bolt catch mechanism and lower receiver's takedown and pivot pins. Clean the buffer, action spring, and inside the lower receiver extension (also called the buffer tube). A cloth attached to the cleaning rod and patch holder can be used to wipe inside the buffer tube. Note that Windham Weaponry uses both Mil Spec & Commercial Specification Buffer Tubes on Telestocked models. Cleaning procedures are similar for Mil. Spec. & A2 (solid stock) models.

3. If the rifle has been used in dirty or muddy conditions, clean out the vent hole in the telestock receiver extension (or the vent screw in the A2 solid buttstock) with a pipe cleaner or piece of wire to ensure that the vent hole is clear.

4. Clean telestock or buttstock as necessary. The telestock latch can be pulled down to remove the stock (as shown in Figures 83 & 84). Clean the 6 position lock holes, and lightly lube the receiver extension and latch mechanism to ensure proper telescoping action. A2 solid buttstocks may require cleaning and lubrication of storage compartment door latch and hinge.



**NOTE:** Some Windham Weaponry rifles sold as "Ban Compliant Models" to meet state specific requirements have permanently extended (fixed length) telestocks. The length of pull cannot be changed as the receiver extension is longer than on an adjustable telestock. See the **differences** noted in Fig. 84A below. The Ban Compliant stock will not have the machined adjustment recesses found on the adjustable telestock.

**DO NOT** attempt to adjust the length of, or disassemble, the Ban Compliant stock as you will damage it.

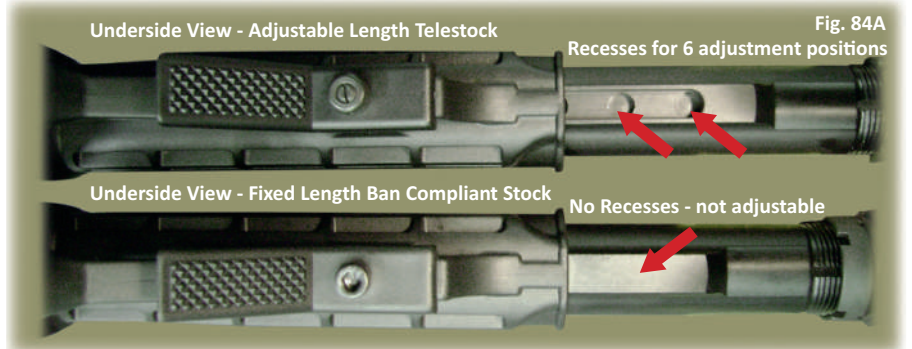

## LUBRICATION OF THE LOWER RECEIVER ASSEMBLY

**LOWER RECEIVER GROUP:** lightly lubricate inside the lower receiver extension (buffer tube), as well as the buffer and action spring.

Generously lubricate the takedown and pivot pins and their detents, all moving parts inside the lower receiver and their pins.



### LOWER RECEIVER REASSEMBLY:

Insert action spring and buffer. You may have to “wiggle” the action spring past the buffer detent as you insert it (Fig. 85).

### JOIN THE UPPER & LOWER RECEIVERS:

1. Position upper receiver so that receiver pivot pin can slide into forward lug of upper receiver.
2. Push pivot pin in, close upper receiver completely onto lower (with hammer cocked).
3. Push in rear takedown pin (Fig. 86).

### A NOTE REGARDING CARBON FIBER RECEIVERS:

Because of very minor dimensional differences, you cannot assemble an Aluminum Upper Receiver Assembly onto a Carbon Fiber Lower Receiver Assembly. Use of force to assemble these components will cause damage. **Conversely**, do not attempt to attach a Carbon Fiber Upper Receiver Assembly onto an Aluminum Lower Receiver Assembly. There are also minor differences between the Carbon Fiber model's barrel nut and that of Aluminum receiver models. Barrel Nut threading is different on Carbon Fiber models, and we also use Loctite on Carbon Fiber Barrel Nuts, so attempting to remove a Carbon Fiber Barrel Nut can cause damage to the Carbon Fiber Upper Receiver, and may void your warranty. This Carbon Fiber Barrel Nut difference limits the number of accessory forends that can be mounted to the Carbon Fiber rifle. Call Windham Weaponry Technical Assistance if you have questions on this.

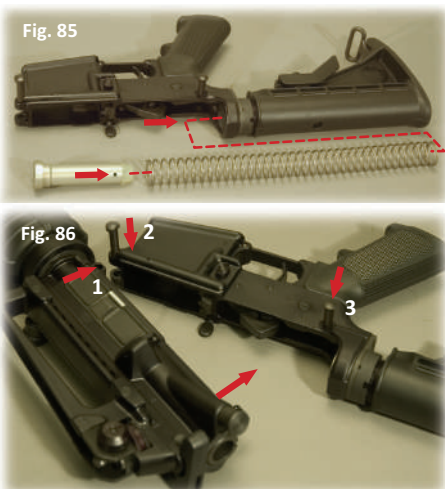

## MAGAZINE DISASSEMBLY & CLEANING

### MAGAZINE DISASSEMBLY

**CAUTION:** Make sure the magazine is unloaded before disassembly.

To disassemble a magazine for cleaning or lubrication, follow these steps:

1. Pry up the back edge of the baseplate with a punch to release the base catch tabs from the magazine body (Fig. 87).

2. Slide the baseplate clear of the body (Fig. 88).

**CAUTION:** The magazine spring will be under tension and may pop out.

3. The magazine spring may get caught on the tabs that hold the baseplate in place. As you pull the spring out of the magazine body, move the spring back and forth so that it will not get hung up on the tabs. Figure 89 shows disassembled magazine components.

**NOTE:** Do not remove the follower from spring.

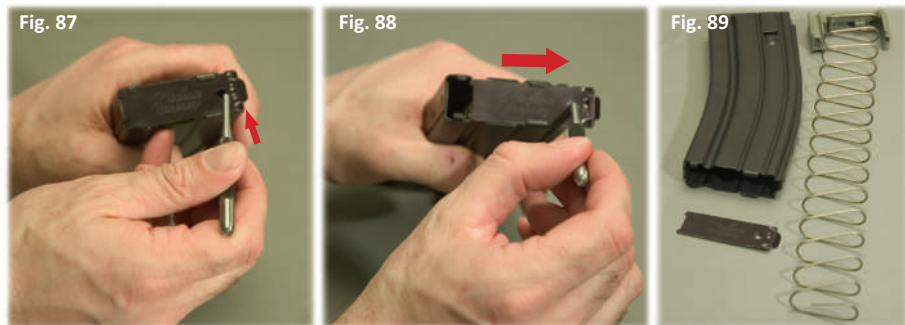

### MAGAZINE CLEANING

To clean and lubricate the magazine, use a cleaning rod with a cleaning patch attached to clean and lubricate the inside of the magazine body.

Lightly lubricate the spring, and reassemble the magazine in the reverse order of the steps above.

## ADDENDUM: INFORMATION ON .308 CALIBER RIFLES



*Just a few of the various Windham Weaponry  
.308 Caliber models are shown above.*

### ALWAYS USE THE CORRECT AMMUNITION FOR YOUR PARTICULAR FIREARM!

*Windham Weaponry Barrels have permanent markings that indicate the proper caliber and chambering. Always refer to the BARREL markings when selecting ammunition for your firearm. Use only factory ammunition manufactured to U.S. industry standards. Failure to use the proper caliber ammunition can damage your firearm, and may cause injury or death.*

The first, and most important point regarding your Windham Weaponry .308 Caliber Rifle is that you should follow all the same maintenance procedures shown elsewhere in this Windham Weaponry Operating and Safety Manual. The .308 Caliber Rifle functions and maintenance procedures are all the same as our .223/5.56mm caliber rifles, and should be followed as shown in the various sections of this Manual.

Below, you'll find the minor differences that set the .308 Caliber Rifles apart from our .223/5.56mm models. If you have any questions regarding maintenance, services or you need parts for your .308 Rifle, please call Toll-Free: 1-855-808 1888, and we will be happy to help.

### What's Different about the .308 Caliber Rifles

- **Caliber:** This rifle is designed - and chambered for - the .308 Winchester round, but it is important to note that it will also chamber and safely fire the common 7.62 x 51mm round. The Magazine supplied with this rifle works equally well with either cartridge.

- **Receivers:** On the .308, the receivers are CNC machined from 7075 T6 Aircraft Aluminum Forgings large enough to contain the caliber specific - and unique - bolt carrier and bolt. The lower receiver has machined sockets each side behind the pistol grip that are intended for Quick Detach sling swivels similar to that supplied on the barrel's gas block. This feature offers multiple sling attachment points.

- **Bolt & Bolt Carrier:** The bolt carrier, bolt assembly, cam pin, and firing pin are unique, and caliber specific to the .308. Other internal parts however, such as Gas Key, Gas Key Screws, and Firing Pin Retaining Pin, are standard "AR" parts.

**NOTE:** There is no Extractor Spring Insert like .223 rifles in the .308, and in disassembling the .308 Carrier, the Cam Pin pulls straight out rather than rotating 1/4 turn as on .223 assemblies.

- **Buffer & Action Spring:** These parts are specific to the .308. The Buffer is shorter, and the Action Spring has a few less coils than an AR, but removal and maintenance are the same. The Telescoping Buttstock is the same as an AR, and the Buffer and Action Spring function in exactly the same way.

- **Trigger Guard:** On the .308 SRC, the Trigger Guard is an integral machined aluminum part of the Lower Receiver, and does not swivel down from the Lower Receiver.



## ADDENDUM: INFORMATION ON .308 CALIBER RIFLES

- **Pivot & Takedown Pins:** The Pivot Pin is longer than an AR type, but held within the Lower with standard AR Detent and Spring. The Takedown Pin is an AR part, and is retained within the Lower by a standard AR Detent and Spring, but is held in place by the Pistol Grip just like the Safety parts rather than from the rear of the Lower like on an AR.

- **Hammer & Trigger:** The Hammer, Trigger, their Springs and Pins, are all AR type parts, and function just as in an AR-15 rifle.

- **Ejection Port Cover & Ejection Port Cover Rod:** The Ejection Port Cover is larger than on an AR in accordance with the larger .308 cartridges, and the Ejection Port Cover Rod is not retained with a C-clip as on an AR, but rather fits in a blind hole so it won't slide out to the rear. Forward movement of the rod is stopped by the Barrel Nut.

- **BARREL:** Windham Weaponry .308 barrels can range from 16.5" to 20" and are turned in Medium Profile and Fluted versions. They all are Chrome Lined in the Bore & Chamber, and machined from Chrome Moly Vanadium 11595E Steel. They are generally fitted with an A2 Type Flash Suppressor specific to the .308 caliber (threaded 5/8ths x 24 tpi), but may also have a plain crowned muzzle. Rifling for .308 models is 1 turn in 10" - Right Hand Twist - 6 Lands & Grooves

The break-in procedure for this Chrome Lined Barrel is similar to the AR type rifles. We recommend breaking the rifle in with any good quality brass cased ammunition - approximately 100 rounds. Then clean the barrel thoroughly, and its ready for the range or the hunt.



- **A CAUTION ABOUT PARTS INTERCHANGEABILITY:** The Windham Weaponry .308 SRC has been developed as a unique product offering, and its parts and components are not intended, or designed, to fit any other manufacturer's .308 rifles regardless of any apparent similarity.

Owners should never attempt to use other manufacturer's parts on or in the Windham Weaponry .308 SRC. To do so could cause damage to your rifle, possibly inflict injury on the shooter or those in the vicinity of the shooter, and could void your warranty.

If you have any questions about your Windham Weaponry .308 SRC, or any of its parts or components, or questions about adding any aftermarket accessories to the rifle, please call the Windham Weaponry Customer Service / Technical Line - Toll Free (1-855-808-1888) between 8:30 AM and 5:00 PM (Eastern Standard Time) Monday through Friday. Or, questions can be E-mailed to: [info@windhamweaponry.com](mailto:info@windhamweaponry.com) and we will respond promptly.

- **Hogue Beavertail Pistol Grip:** This is a quality aftermarket part that while not specific to only the .308 SRC, is nevertheless very well suited for it. It fits larger hands a bit better, and its "beavertail backstrap" snugly fits the Lower Receiver and provides better padding for the webbing between the thumb and index finger with the slightly heavier recoil of the .308 cartridge.

- **Bolt Catch Screw:** The attachment of the Bolt Catch on the .308 Lower Receiver is different than on AR lowers. A special Allen head pin/screw (with 1/16" socket) is used to hold the Bolt Catch in place. The function and operation of the Bolt Catch are identical to the AR type rifle.



## ADDENDUM: INFORMATION ON .308 CALIBER RIFLES

- **Charging Handle:** Longer, and specific to the .308, the Charging Handle is machined from 7075 T6 aluminum like its AR counterpart and the Latch, Latch Spring and Spring Pin are also standard AR parts.



- **Handguards & Gas Tube:** The Handguards are mid-length, and removal or installation is identical to shorter AR type parts. The Gas Tube is also a .308 mid-length unit (shown superimposed over the handguards in this photo). Its gas impingement system function, any cleaning / maintenance procedures, are identical to the AR.



- **.308 Gas Block:** While identical in function to the units found on .223 rifles, this gas block has been machined to receive the Quick Detach Push Button Sling Swivel shown here to offer rapid adjustment of sling positions, and ease in stripping down the rifle for cleaning or maintenance operations. The Picatinny Rail on the Gas Block is on the same plane as the Upper Receiver for optimum sight function.



- **.308 Questions?:** Feel free to call our Customer Service or Tech Support Line Toll Free any time between 8:30 AM and 5:00 PM E.S.T.: **1-855-808-1888**

## ADDENDUM: INFORMATION ON 7.62x39 CAL. RIFLES

**ALWAYS USE THE CORRECT AMMUNITION FOR YOUR PARTICULAR FIREARM!**

*Windham Weaponry Barrels have permanent markings that indicate the proper caliber and chambering. Always refer to the BARREL markings when selecting ammunition for your firearm. Use only factory ammunition manufactured to U.S. industry standards. Failure to use the proper caliber ammunition can damage your firearm, and may cause injury or death.*



Windham Weaponry  
7.62x39mm Caliber SRC  
(Model R16M4FTT-762)

Again, we stress in this Operating Manual that you should follow all the same maintenance procedures shown for our .223 / 5.56mm models. The 7.62 x 39mm SRC functions and maintenance procedures are all the same and should be followed as shown in the various sections of this Manual.

On the next page, we will identify the minor differences that set the 7.62 x 39mm Caliber Rifles apart from our .223/5.56mm models. If you have any questions regarding maintenance, service or you need parts for your 7.62 x 39mm Rifle, please call Toll-Free: **1-855-808 1888** and we will be happy to help.



# What's Different about the 7.62x39mm Caliber Rifles

• **Caliber:** This rifle is designed and chambered for the 7.62 x 39mm cartridge. This is the world famous ammunition used most commonly in the Russian designed "AK47". We recommend using brass cased ammunition and, although it may seem obvious, **DO NOT attempt to fire .223 Rem / 5.56mm ammunition in this rifle.**



Case length 38.70 mm (1.524 in)  
Overall length 56.00 mm (2.205 in)

• **Bolt:** Due to the larger case diameter, the Bolt and Extractor are unique - and caliber specific - to the Windham Weaponry 7.62 x 39mm SRC. This Bolt is identified by the 3 rings machined into the body behind the lugs. Internal Bolt Carrier parts however, such as Gas Key, Gas Key Screws, Enhanced Firing Pin and Firing Pin Retaining Pin, are standard "AR" parts. Note: The 7.62 bolt does not use the extractor o-ring commonly found in .223 rifles



• **Receivers:** On the 7.62 x 39mm SRC, the receivers are CNC machined from 7075 T6 Aircraft Aluminum Forgings - just the same as our .223 Rem / 5.56mm rifles. They are however marked differently than our .223 / 5.56mm lower receivers, and are stamped with "Multi" so that we can utilize them for a variety of calibers. Internal Receiver parts such as the Hammer, Trigger, their Springs and Pins, Buffer and Buffer Spring, etc. are all AR type parts, and function just as in an AR-15 rifle.



• **Barrel / Gas Block:** The Barrel on the 7.62 x 39mm SRC is chambered and bored for the 7.62 x 39mm cartridge. Rifling twist rate is 1 in 9.5", right hand twist with 4 lands and grooves. The Gas Block/Front Sight Base is functionally identical to the units found on AR rifles and the Mil. Std. 1913 Rail is on the same plane as the Upper Receiver for optimum sight function.



• **Flash Hider:** We use the same A2 "Birdcage" type Flash Hider as found on our .308 rifles. Threading is  $\frac{3}{8}$ -24.



• **7.62 x 39mm Magazine:** Shipped with the Windham Weaponry 7.62 x 39mm SRC is a 30 Round AR Pattern Magazine designed specifically to hold that round. Note that you should not attempt to load more than 30 Rounds into this magazine as it could cause reliability issues.

7.62 x 39 Magazines of other capacities are available (10 Rd / 5 Rd), and will fit and function in this rifle. Additional magazines can be ordered by calling **1-855-808-1888** or on line at [www.windhamweaponry.com](http://www.windhamweaponry.com)

• **A Caution About Parts Interchangeability:** The Windham Weaponry 7.62 x 39mm SRC has been developed as a unique product offering, and its parts and components are not intended, or designed, to fit any other manufacturer's 7.62 x 39mm rifles regardless of any apparent similarity.

Owners should never attempt to use other manufacturer's parts on or in the Windham Weaponry 7.62 x 39mm SRC. To do so could cause damage to your rifle, possibly inflict injury on the shooter or those in the vicinity of the shooter, and could void your warranty.



• **7.62 x 39mm Questions?:** If you have any questions about your Windham Weaponry 7.62 x 39mm SRC, or any of its parts or components, or questions about adding any aftermarket accessories to the rifle, please call the Windham Weaponry Customer Service / Technical Line - Toll Free (**1-855-808-1888**) between 8:30 AM and 5:00 PM (Eastern Standard Time) Monday through Friday. Or, questions can be E-mailed to: [information@windhamweaponry.com](mailto:information@windhamweaponry.com) and we will respond promptly.

## ADDENDUM: INFORMATION ON .300 BLACKOUT CALIBER RIFLES

### ALWAYS USE THE CORRECT AMMUNITION FOR YOUR PARTICULAR FIREARM!

*Windham Weaponry Barrels have permanent markings that indicate the proper caliber and chambering. Always refer to the BARREL markings when selecting ammunition for your firearm. Use only factory ammunition manufactured to U.S. industry standards. Failure to use the proper caliber ammunition can damage your firearm, and may cause injury or death.*



Windham Weaponry  
.300 Blackout SRC  
(Model R16FTT-300)

As with our .308 and 7.62 rifles, you should follow all the same maintenance procedures shown for our .223 / 5.56mm models. The .300 Blackout functions and maintenance procedures are all the same and should be followed as shown in the various sections of this Manual.

- **Caliber:** This rifle is designed and chambered for the .300 Blackout cartridge. It will also chamber and fire the 7.62 x 35mm cartridge. We always recommend using brass cased ammunition. **DO NOT attempt to fire .223 Rem. / 5.56mm ammunition in this rifle.** Compare the two cartridges at right.

- **Bolt:** Because the case bases are the same dimensions, the Bolt and Extractor are the same as our .223/5.56mm rifle.

- **Receivers:** On the .300 Blackout Rifle, the receivers are CNC machined from 7075 T6 Aircraft Aluminum Forgings - just as our .223 Rem / 5.56mm rifles. The Upper Receiver is laser engraved .300 Blackout for safety and quick identification. The Lower Receiver is marked "Multi" so that we can utilize them for a variety of calibers. Internal Receiver parts such as the Hammer, Trigger, their Springs and Pins, Buffer and Buffer Spring, etc. are all AR type parts, and function just as in an AR-15 rifle.

- **Barrel / Gas Block:** The Barrel on .300 Blackout Rifle is machined in a medium profile, and chambered and bored for the .300 Blackout cartridge. Rifling twist rate is 1 in 7", right hand twist. The Gas Block/Front Sight Base is functionally identical to the units found on AR rifles.

- **Muzzle Brake:** Threading is  $\frac{1}{8}$ -24. Other similarly threaded brakes and flash hidiers designed for .30 caliber rifles may be compatible.

- **.300 Blackout Magazine:** The .300 Blackout Rifle accepts AR Pattern Magazines. We ship the rifle with one 30 Round Magazine - other capacity magazines are available.

**BE VERY CAREFUL not to mix magazines filled with .300 Blackout ammunition with .223 magazines.** Shooting .300 Blackout will cause catastrophic failure in a .223/5.56

- **A Caution About Parts Interchangeability:** Owners should not attempt to use other manufacturer's parts on or in the Windham Weaponry .300 Blackout Rifle. To do so could cause damage to your rifle, possibly inflict injury on the shooter or those in the vicinity of the shooter, and could void your warranty.

If you have any questions regarding maintenance of the .300 Blackout Caliber Rifles, or you need parts for your .300 Blackout, please call Toll-Free: **1-855-808 1888** and we will be happy to help.

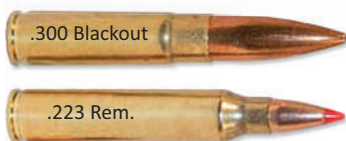

# TROUBLESHOOTING - PROBLEMS & SOLUTIONS

PROBLEM:	CHECK FOR:	WHAT TO DO:
Rifle will not fire...	Selector lever on safe.	Move selector lever to fire.
	Improper assembly of firing pin.	Assemble correctly - retaining pin must be positioned behind large shoulder on firing pin.
	Too much oil, or fouling in firing pin recess.	Remove bolt & firing pin. With pipe cleaner, clean out hole in bolt face. Clean firing pin. Lubricate & reassemble.
	Defective ammunition.	Remove & discard. Use only fresh, clean ammunition appropriate to the caliber marked on the barrel of your rifle.
Bolt will not easily unlock...	Dirty or burred bolt.	Clean bolt & locking lugs in firing chamber. Replace bolt if necessary, or consult with the factory or a qualified gunsmith.
Bolt will not extract...	Weak or broken extractor spring.	Replace the extractor spring and insert.
	Dirty or corroded ammunition.	Possible stuck round. If possible, remove the upper receiver from the lower. Clear the weapon. Push out round with cleaning rod from muzzle end.
	Carbon in firing chamber.	Clean firing chamber & bolt locking lugs.
	Fouling or carbon in extractor recess or lip.	Remove bolt, disassemble extractor. Clean extractor, lip, & related areas of bolt.
	Frozen extractor.	Remove bolt, disassemble extractor. Clean & lubricate.
	Broken extractor.	Remove & replace extractor.
Rifle will not feed ammunition...	Dirty magazine.	Disassemble & clean magazine box, follower & spring.
	Defective magazine.	Replace defective magazine.
	Too many rounds in magazine.	Remove excess ammunition.
	Action of buffer assembly is restricted.	Remove buffer & spring. Clean, lubricate & reinstall.

Fig. 90



Fig. 91

## TROUBLESHOOTING - PROBLEMS & SOLUTIONS (continued)

PROBLEM:	CHECK FOR:	WHAT TO DO:
Rifle will not feed ammunition...	Magazine not fully seated.	Slap up on the bottom of the magazine to ensure it is seated correctly in the magazine well. Then pull down on the magazine to ensure the magazine catch is properly engaged with the magazine.  Fig. 92
Double feed...	Defective magazine.	Replace defective magazine.
Rifle will not chamber a round...	Dirty or corroded ammunition.	Clean the ammunition, or remove & discard. Use only fresh, clean ammunition appropriate to the caliber marked on the barrel of your rifle.
	Damaged ammunition.	Replace damaged ammunition.
	Carbon or fouling in chamber area or in barrel locking lugs.	Clean firing chamber area & bolt locking lugs.  Fig. 93
Short recoil...	Restricted movement of bolt carrier group.	Remove bolt carrier. Clean & lubricate all components. Before putting bolt back in, make sure gas tube fits into carrier key, and that the carrier moves freely.
	Gaps in bolt gas rings aligned correctly.	Gaps in the 3 gas rings should be staggered 120° around the bolt body to ensure proper gas pressure.  Fig. 94
	Carbon or dirt in carrier key or on outside of gas tube.	Clean these areas.  Fig. 95
	Underpowered ammunition.	Use newly manufactured, quality ammunition.
	Loose gas key.	Contact Customer Service toll free at: <b>1-855-808-1888</b>



## TROUBLESHOOTING - PROBLEMS & SOLUTIONS (continued)

PROBLEM:	CHECK FOR:	WHAT TO DO:
Bolt fails to lock after last round...	Dirty or corroded bolt catch.	Clean bolt catch.
	Faulty magazine.	Replace defective magazine.
Selector lever binds...	Needs oil.	Lubricate with CLP.
	Obstruction under trigger.	Clean or flush out lower receiver & lubricate.
	Hammer position.	The safety selector will only rotate when the hammer is in the cocked position.
Failure to eject...	Frozen or stiff ejector.	Lubricate ejector with CLP and use a punch to work ejector in and out of bolt face.

**NOTE: If the problem still persists, see the short recoil solutions.**

**NOTE: If the problem still persists, call Customer Service toll free at: 1-855-808-1888**

Bolt carrier "hang up"...

Round jammed between bolt and charging handle.

**WARNING: Keep clear of muzzle.**

**With rifle pointed in a safe direction...**

- STOP**
1. Remove magazine.
  2. Push in on bottom of the bolt catch.
  3. Pull charging handle to the rear. If the bolt carrier does not lock to the rear, while pulling the charging handle rearward, bang the buttstock on a solid surface (Fig. 96).
  4. Once the bolt is locked to the rear, place the safety selector in the safe position.
  5. Push the charging handle forward and the round should become dislodged (Fig. 97).

**Inspect that round, and discard if damaged.**

**CAUTION:** After round is removed, bolt is under tension.

**NOTE:** If this procedure fails, use a section of cleaning rod to push bolt fully to rear through the ejection port.



Fig. 96



Fig. 97

# TROUBLESHOOTING - PROBLEMS & SOLUTIONS (continued)

**PROBLEM:** CHECK FOR:

**WHAT TO DO:**

Double feed...



***With rifle pointed in a safe direction...***

1. Remove magazine.
2. Push in on bottom of the bolt catch.
3. Pull charging handle to the rear and lock the bolt carrier in place.
4. Place the safety selector in the SAFE position.
5. Rounds should fall out of the rifle through the magazine well.
6. Visually inspect to ensure that all rounds are clear from the rifle.

***Inspect and discard any damaged ammunition.***

---

## SHIPPING RIFLES FOR SERVICE

**For Owners Within The United States... CONTACT CUSTOMER SERVICE:**

Tel: 207 893 2223 • Sales Line: 855 808 1888 • E-mail: [info@windhamweaponry.com](mailto:info@windhamweaponry.com)

**RETURNS FOR SERVICE:** Should your Windham Weaponry Firearm require service, it should be returned to the Windham Weaponry factory.

• Call or E-mail the Customer Service Dept. for authorization and shipping instructions.

• **ENSURE THAT THE FIREARM IS UNLOADED.**

• **DO NOT SHIP ANY AMMUNITION.**

• Do not attempt to ship a Firearm via US Postal Service (only Federally Licensed Dealers may ship Firearms by Postal Service).

• Enclose a letter which includes your full name and street address (no P.O. Boxes), daytime telephone number, e-mail address, the serial number of the firearm, and details of problem experienced (stating the brand and type of ammunition used when the problem occurred), or work desired. We recommended that you insure your shipment.

• Record the serial number before shipping, in case you wish to check on the repair status of your Firearm.

• Please remove all custom parts and accessories, such as stocks, special sights and scopes, or slings from your firearm before returning.

• Place the Firearm in its original case or in a similar secure container, and pack it snugly.

• The package must NOT bear any markings which indicate the identity of the contents.

---

***This Operating and Safety Instruction Manual should always be kept with your Windham Weaponry firearm. If the rifle is sold, the manual should be transferred to the new owner.***

Model: \_\_\_\_\_

Serial Number: \_\_\_\_\_

Sold To: \_\_\_\_\_

Date Sold: \_\_\_\_\_

# **ALWAYS FOLLOW THE RULES OF SAFE GUN HANDLING!**

## ***FOLLOW ALL INSTRUCTIONS ON THE PROPER HANDLING AND SAFE USE OF THIS FIREARM!***

- ALWAYS HANDLE your firearm as if it were loaded.
  - NEVER POINT your firearm at anything you do not intend to shoot.
  - KNOW YOUR TARGET and beyond.
  - USE EYE & EAR PROTECTION when shooting.
  - DO NOT TOUCH the trigger unless you are ready to fire.
  - DO NOT RELY on the firearm's safety - it should only be considered a supplement to safe firearm handling.
  - NEVER LEAVE a loaded firearm unattended.
  - ONLY USE AMMUNITION designed for your firearm. Failure to use the proper caliber ammunition can damage your firearm and may result in injury or death.
  - ONLY USE QUALITY commercial ammunition that is in good condition. Using corroded, lacquer coated, damaged, hand loaded, steel or aluminum cased ammunition may void the warranty, and may cause injury or death.
  - BE SURE YOUR FIREARM is unloaded and the bolt is open before handing it to others.
  - DO NOT HANDLE FIREARMS while impaired or the influence of alcohol or drugs.
  - DO NOT ALLOW others to handle or shoot your rifle if they have not read the safety guidelines in this manual.
- DO TAKE** a firearms safety course!

### ***RIFLE SPECIFIC WARNINGS:***

- BOLT CAM PIN must be installed or rifle will suffer catastrophic failure when fired. Injury or death may result.
- IF THERE IS WATER, too much oil, or an obstruction in the barrel, do not fire. It may explode and cause injury or death to you or those around you.
- DO NOT DROP your firearm, it may discharge. A firearm dropped on its butt may chamber a round.
- DO NOT EXCHANGE bolt assemblies from one rifle to another. While Windham Weaponry rifles and bolts are machined with great care, and are interchangeable with other Windham Weaponry bolts, we do not recommend exchanging bolts - particularly those from other manufacturers, without first checking for proper headspacing with a Field Gauge or Go/No-Go Gauge for .223 Rem. /5.56mm NATO - or gauges appropriate to the caliber of your rifle.

### ***BE SAFE WORKING WITH YOUR FIREARM!***

- BEFORE INSPECTION OR MAINTENANCE, be sure to clear the rifle. Do not pull the trigger until the rifle has been cleared. Inspect the firing chamber to ensure that it is empty and the magazine has been removed.
- DO NOT KEEP ammunition near your work area.
- ONLY THE FACTORY or a qualified gunsmith should service, repair or modify your firearm in any way.

### ***CAUTIONS REGARDING TOXINS & PARTS:***

- CLEANING, DISCHARGING, HANDLING of your firearm and ammunition may result in exposure to lead - a toxic and hazardous substance. Wash hands thoroughly after exposure.
- TO AVOID INJURY to your eyes, use care and wear safety glasses when removing and installing spring-loaded parts of your firearm.



Windham Weaponry • Windham Business Park  
999 Roosevelt Trail • P.O. Box 1900 • Windham, ME 04062  
Telephone: 207 893 2223 • Fax: 207 893 1623 • Sales Line: 855 808 1888  
E-mail: [information@windhamweaponry.com](mailto:information@windhamweaponry.com) [WWW.WINDHAMWEAPONRY.COM](http://WWW.WINDHAMWEAPONRY.COM)



## TRANSFERABLE LIMITED LIFETIME WARRANTY\*

Windham Weaponry, Inc. (WWI) will warranty all firearms manufactured by WWI against any and all manufacturer's defects in material and workmanship which affect reasonable operation *for the lifetime of the firearm* to the purchaser. *This warranty is transferable from the original purchaser to a subsequent buyer.*

Warranty is established by registering online at:

<http://www.windhamweaponry.com>

or by phone with our Customer Service department at **855-808-1888**.

Warranty claims may be made by contacting Customer Service, either in writing or by phone for a Return Authorization number prior to delivering the unloaded firearm to Windham Weaponry, Inc., 999 Roosevelt Trail, Windham, Maine 04062, freight prepaid by the purchaser. Firearms and ammunition must be shipped separately. No COD shipments will be accepted.

WWI will repair or replace only those parts determined to be defective by the factory. This warranty does not apply to normal wear and tear of any parts or protective finishes.

The following are specifically excluded from coverage under this warranty and will cause said warranty to become null and void:

Damage or malfunction resulting from accident, negligence, misuse or unauthorized repair or alteration; barrel obstruction; use of ammunition other than NATO and/or SAAMI specification new production ammunition; use of any hand loaded, reloaded, imported or factory re-manufactured ammunition; failure to provide reasonable and necessary maintenance as described in the Operator's Manual accompanying the firearm; rust or corrosion; use of replacement parts other than parts authorized by WWI for use in WWI firearms; any unauthorized repair or any alteration, including of a cosmetic nature, performed on the firearm by an individual, organization, company or entity other than WWI; unreasonable or excessive use of the firearm.

Any finished products that are not assembled at our facilities, or are assembled using imported or used parts. This includes complete rifle kits, upper receivers, lower receivers, barrel assemblies, etc.

No implied warranties of any kind are made herein. Limited Lifetime Warranty does not apply to any accessory items.

WWI assumes no liability for accidental or consequential damages. Some states do not allow the exclusion or limitation of accidental or consequential damages and therefore this limitation may not apply to you.

### **\* U.S. Customers Only**

Windham Weaponry • 999 Roosevelt Trail • P.O. Box 1900 • Windham, ME 04062

Telephone: 207 893 2223 • Fax: 207 893 1623 • Sales Line: 855 808 1888

E-mail: [information@windhamweaponry.com](mailto:information@windhamweaponry.com)    [www.windhamweaponry.com](http://www.windhamweaponry.com)

## ACTIVATING YOUR WARRANTY

As soon as possible upon receipt of your Windham Weaponry Firearm, go online, or call, to activate your Transferable Limited Lifetime Warranty.

See: [www.windhamweaponry.com](http://www.windhamweaponry.com) / or call Toll-Free: **855-808 1888**

Follow the Instructions on the Website Warranty Page. Your Windham Weaponry Firearm's Warranty will be in effect upon completion of these steps.

The Windham Weaponry Team thanks you for your purchase of this fine rifle, and we hope you will enjoy it safely for many years. If you need parts, service or advice concerning your rifle, we are never more than a phone call away, and will be pleased to help you.